

垂直

目標時間	5分
------	----

NO.2

名前

1 点アを通り直線イに垂直な直線をひきましょう。
 (方眼紙を利用しましょう。)

①

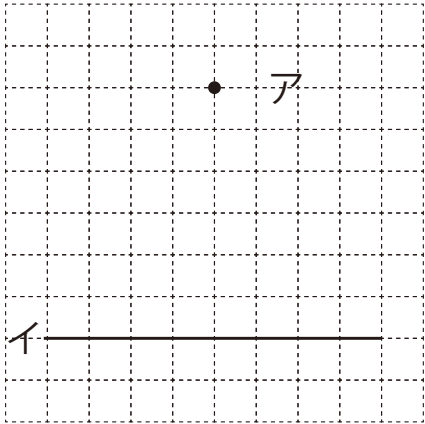

②

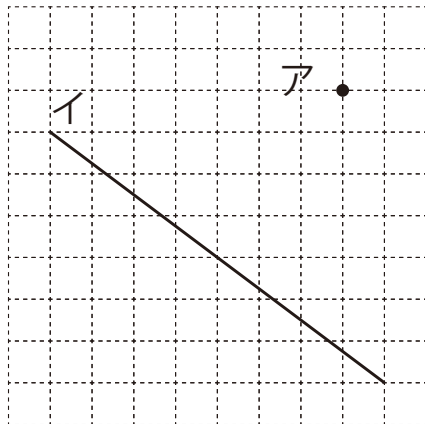

2 点アを通り直線イに垂直な直線をひきましょう。
 (三角定規を使いましょう。)

①



②

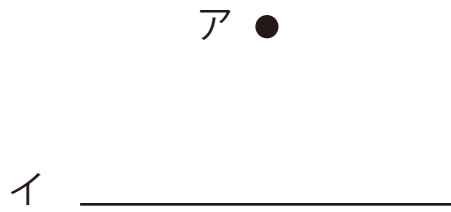

③

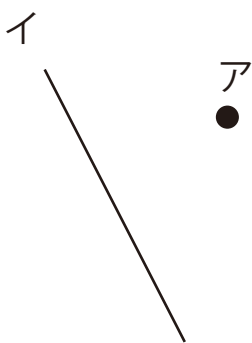

④

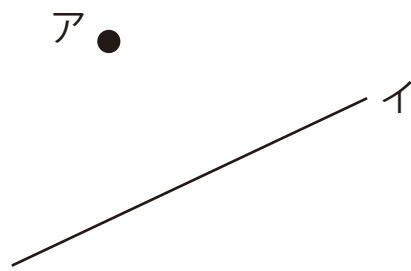

答え

1

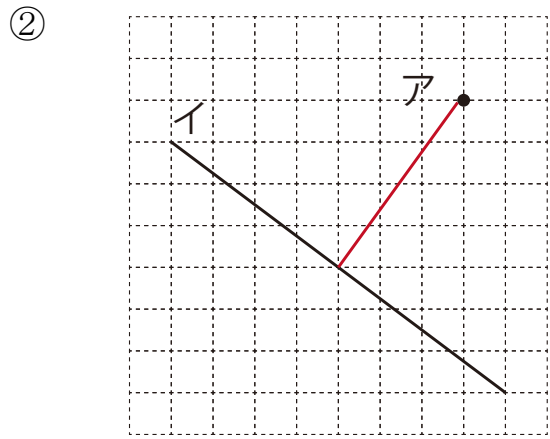
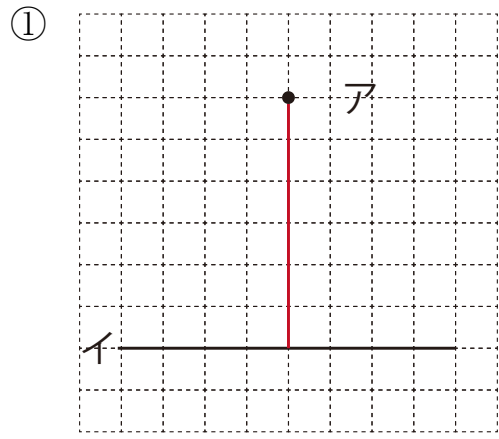

2

